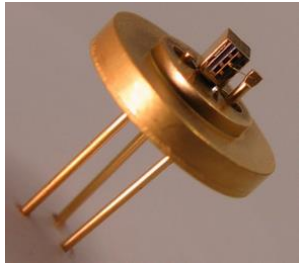

GC-780-40-TO-100-B	
Curved stripe gain chip for 750-800nm tuning range	
	<p>Features:</p> <ul style="list-style-type: none"> • Optimized for wavelength locked operation in external cavity system • High Signal/ASE ratio • Narrow line <p>Application:</p> <ul style="list-style-type: none"> • External cavity tunable laser
<h2>Specification</h2>	DATE: 17 th February 2015

RECOMMENDED OPERATING POINT				
Parameter	Min	Typ	Max	Unit
Current		250	300*	mA
Forward voltage		2	2.2	V
Heatsink temperature	20	25	30	C

*No self-lasing up to maximum current

TUNABILITY				
@ CW, recommended operating point, external cavity in Littman configuration with ≈10% feedback				
Parameters	Min	Typ	Max	Unit
Wavelength of maximum power (λ_{MP})	770	780	790	
Optical output power @ λ_{MP}	80	110		mW
Central wavelength of tuning range	760	775	790	nm
Tuning range width		40		nm

AMPLIFIED SPONTANEOUS EMISSION (ASE)				
Tested for each device @ CW, recommended operating point, without external cavity				
Parameter	Min	Typ	Max	Unit
Optical power		20		mW
Mean wavelength		770		nm
Bandwidth @ -3dB*		16		nm
Fast axis beam divergence @ -3dB	15	20	25	deg.
Slow axis beam divergence @ -3dB	4	7	12	deg.

* Radiation coupled in single-mode fiber without lens and measured by OSA with 1 nm resolution.

CHIP PARAMETERS				
Parameter	Min	Typ	Max	Unit
Chip length		2		mm
Back-reflection from back facet (HR-coated)	99			%
Back-reflection from front facet (AR-coated)			0.001	%

TYPICAL PERFORMANCE IN EXTERNAL CAVITY (EC)

@ CW, 25°C heatsink temperature, Littman configuration with ≈10% feedback

Optical spectra @ 250mA (res. 0.2 nm)

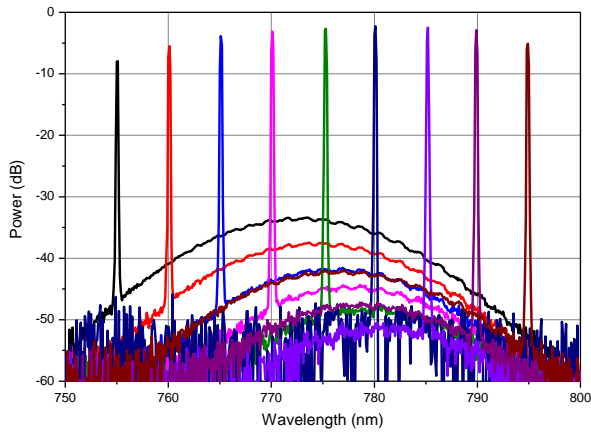

Optical spectra @ 250mA (res. 10 pm)

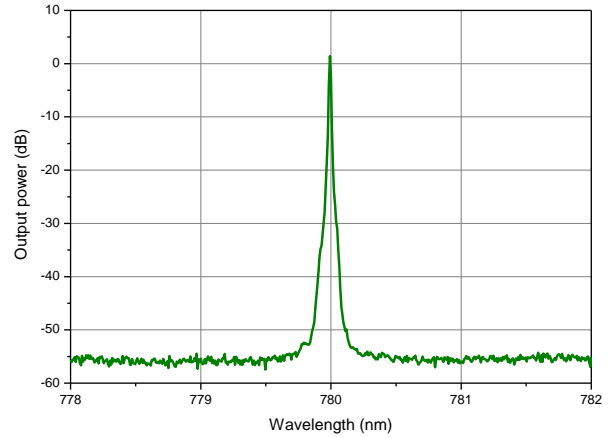

Output power spectra

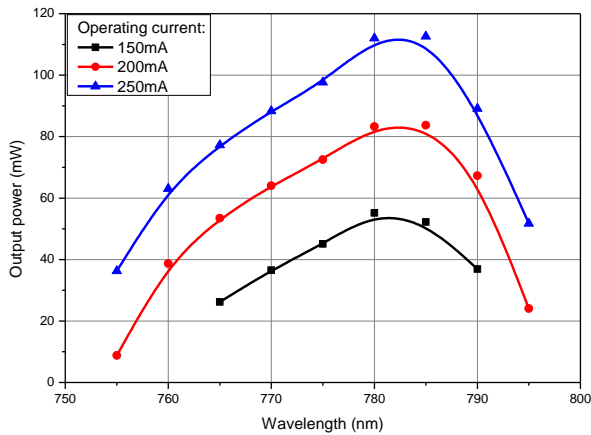

Signal/ASE ratio @ 250mA

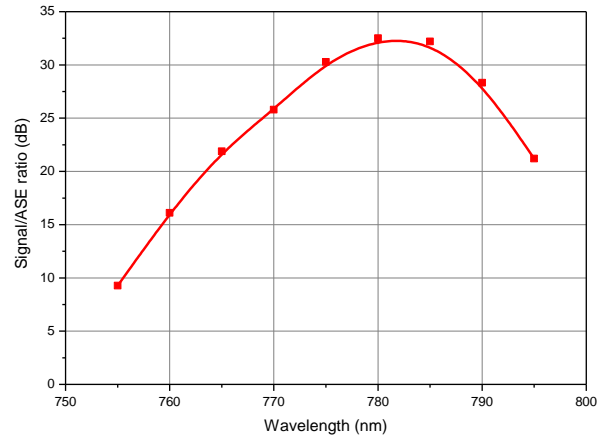

Output power @ 780 nm

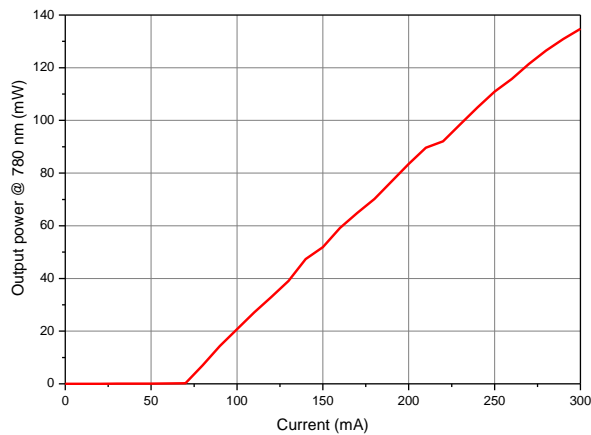

Threshold current

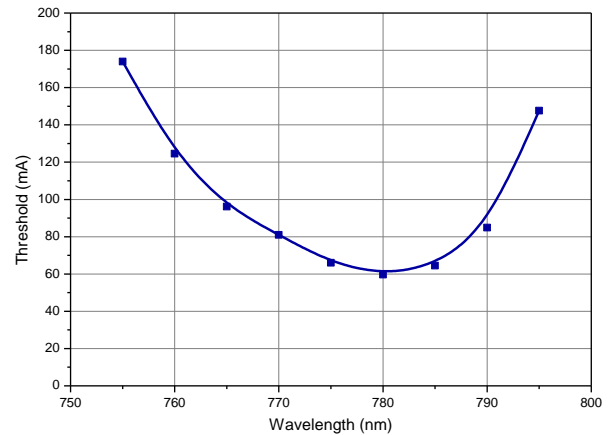

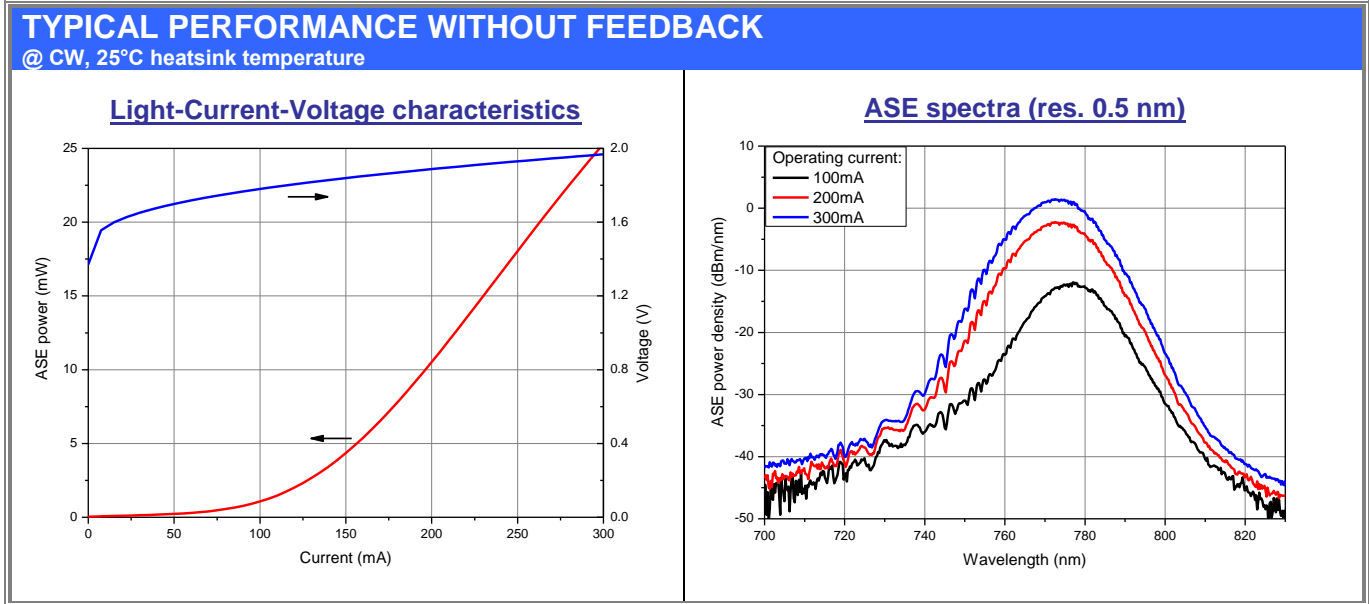

ABSOLUTE MAXIMUM RATINGS

Parameters	Min	Max	Unit
Diode reverse voltage		1	V
Forward current		300	mA
Storage temperature (in original hermetically sealed package)	5	50	°C
Heatsink operating temperature	20	40	°C

CHIP VISUAL ACCEPTANCE CRITERIA

Top view:	no indentations deeper 30um on cleaved edges, no scratches or indentations on mesa
Front facet view:	no particles or defects of coating in 10-um area around mesa

DIMENSIONS (subject to change) (All sizes in mm)

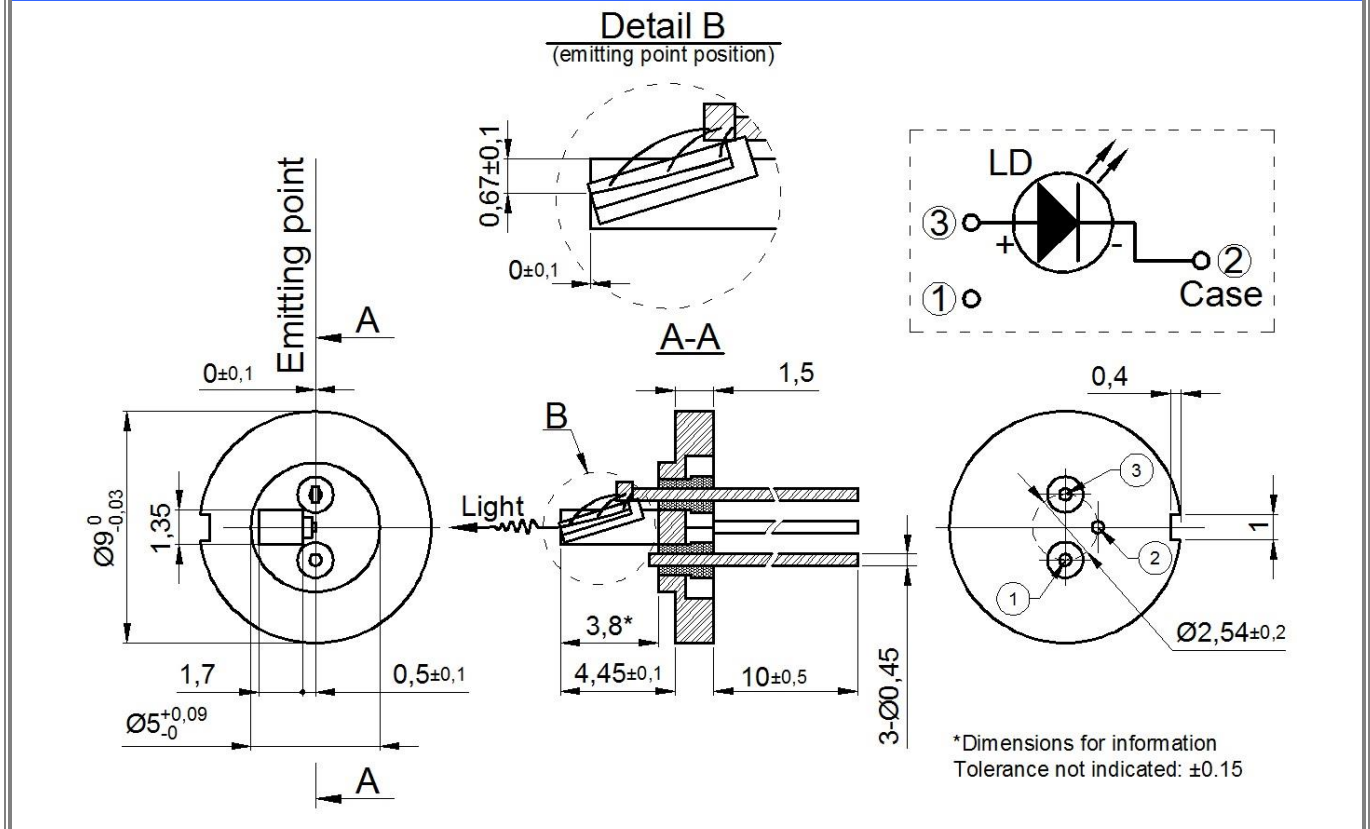

SAFETY AND OPERATING INSTRUCTIONS

The laser light emitted from this device is invisible and can be dangerous to the human eye. Avoid looking directly into the fiber output or into the collimated beam along its optical axis when the device is in operation. Proper laser safety eyewear must be worn during operation.

Absolute Maximum Ratings may be applied to the device for short period of time only. Exposure to maximum ratings for extended period of time or exposure above one or more max ratings may cause damage or affect the reliability of the device. Operating the product outside of its maximum ratings may cause device failure or a safety hazard. Power supplies used with the device must be employed such that the maximum peak optical power cannot be exceeded. A proper heatsink for the device on thermal radiator is required, sufficient heat dissipation and thermal conductance to the heatsink must be ensured.

The device is an open-heatsink laser diode; it may be operated in cleanroom atmosphere or dust-protected housing only. Operating temperature and relative humidity must be controlled to avoid water condensation on the laser facets. Any contamination or contact of the laser facet must be avoided.

ESD PROTECTION – Electrostatic discharge is the primary cause of unexpected product failure. Take extreme precaution to prevent ESD. Use wrist straps, grounded work surfaces and rigorous antistatic techniques when handling the product.



NOTE: Innolume product specifications are subject to change without notice.