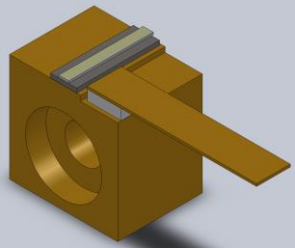

TA-1080-50-CM-3W Tapered amplifier on C-mount	
	<p>Features:</p> <ul style="list-style-type: none"> • High output power • No self-lasing • High Signal/ASE ratio • Strong linear polarization (TE) <p>Application:</p> <ul style="list-style-type: none"> • Frequency doubling
Specification	DATE: 12 st December 2018

Parameters				
@ CW				
Operating point	Min	Typ	Max	Unit
Operating current (I_{op})		7	8*	A
Forward voltage		1.45	1.6	V
Heatsink temperature	20	25		°C
Amplification				
Input power** (P_{IN})		30	50	mW
Wavelength of maximum power (λ_{MP})	1065	1090	1095	nm
Output power @ λ_{MP} , P_{IN}	2.5	3		W
Wavelength tuning range	50			nm
Coupling efficiency into single-mode fiber***	50	65		%
Signal to noise ratio (SNR)	45	55		dB
Amplified spontaneous emission (ASE) w/o input light				
Optical power from ridge side (RS)		2.5		mW
Optical power from tapered side (TS)		26		mW
Fast axis beam divergence (FWHM)		18	25	deg.
Slow axis beam divergence (FWHM) @ RS	4	7	10	deg.
Slow axis beam divergence (FWHM) @ TS		20		deg.
Polarization extinction ratio (PER)	15			dB

*No self-lasing up to maximum current

**Input light power is shown with regard to coupling.

*** Measured in optical scheme with 3 lenses: Thorlabs C330TM-C, LJ1695RM-C, C280TM-C. Fiber - PM980 with FC/APC connector.

Chip parameters				
Parameter	Min	Typ	Max	Unit
Chip length		4		mm
Output aperture width		230		um

TYPICAL PERFORMANCE WITH INPUT SIGNAL @ CW, operating point

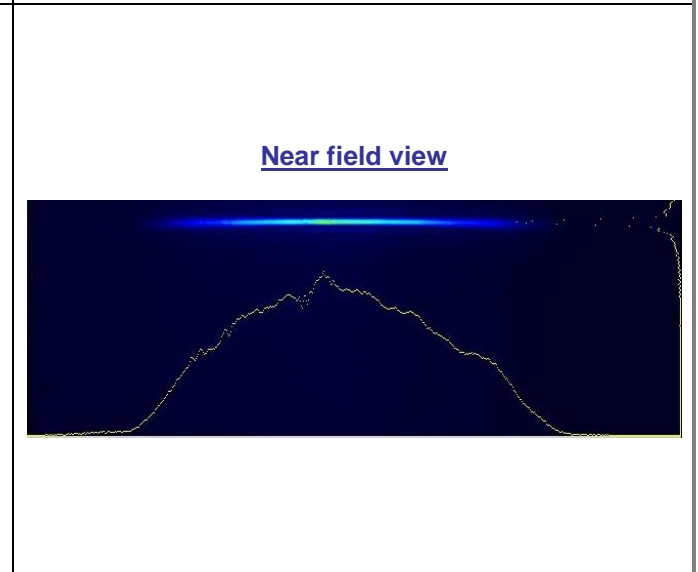
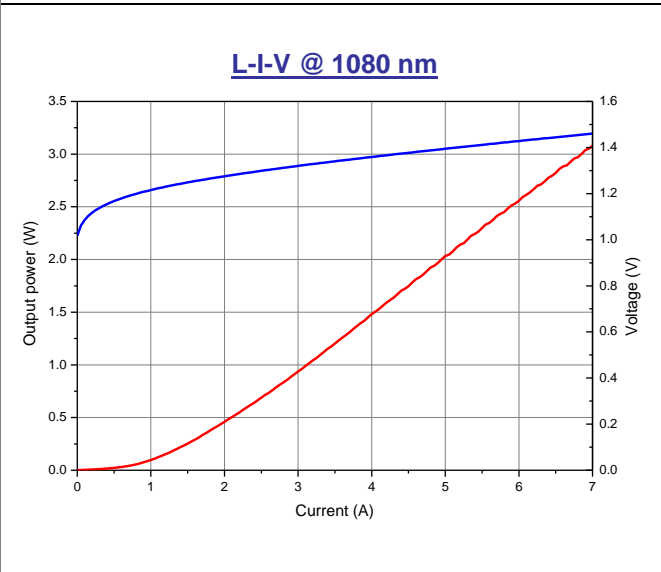
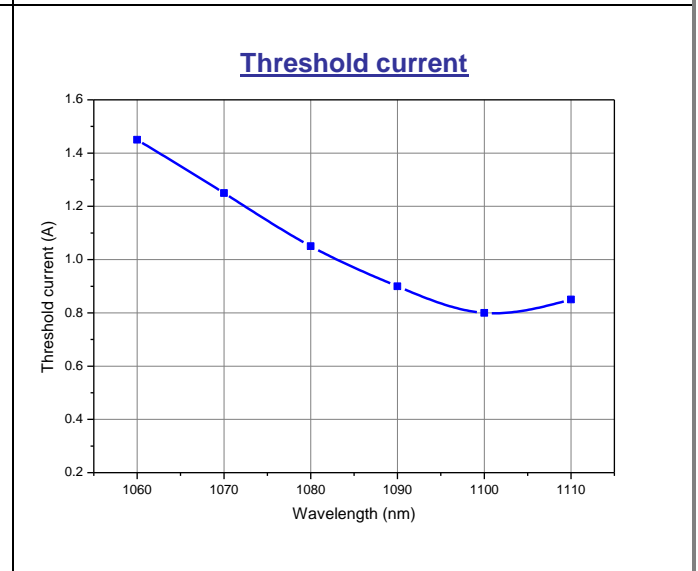
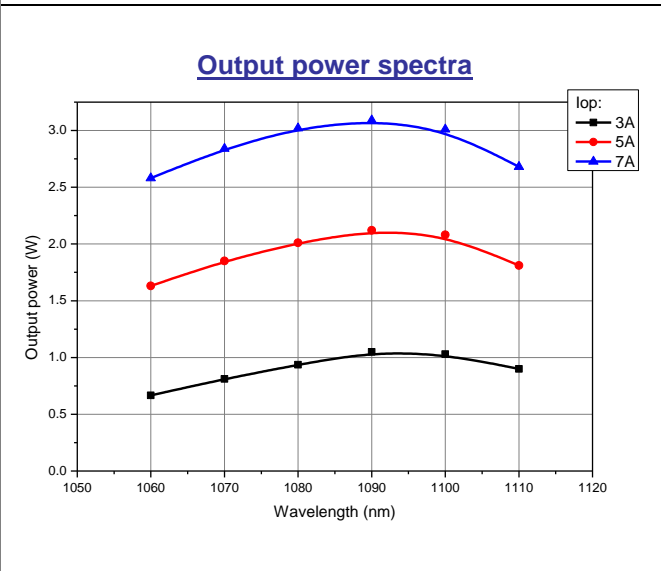
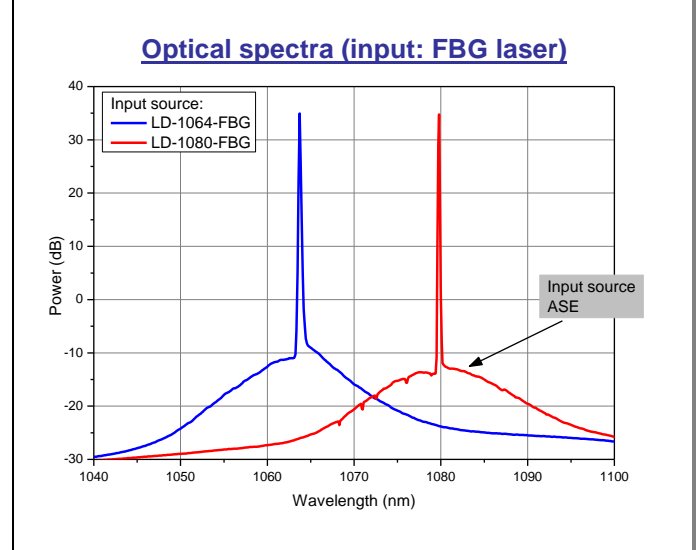
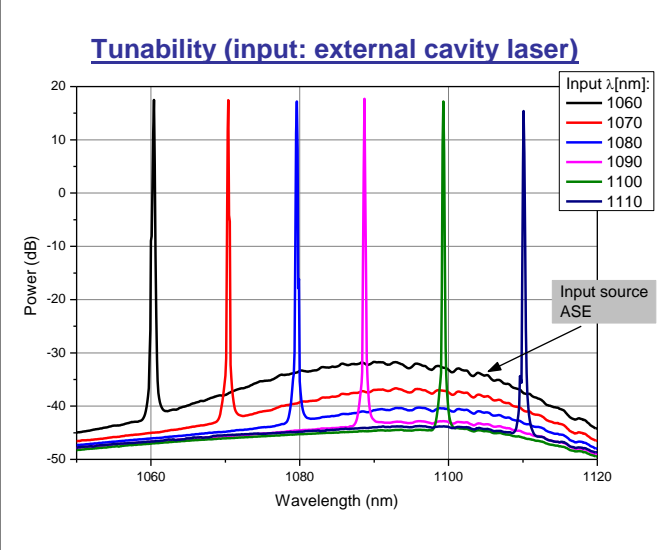

TYPICAL PERFORMANCE WITHOUT INPUT SIGNAL

@ CW, 25°C heatsink temperature

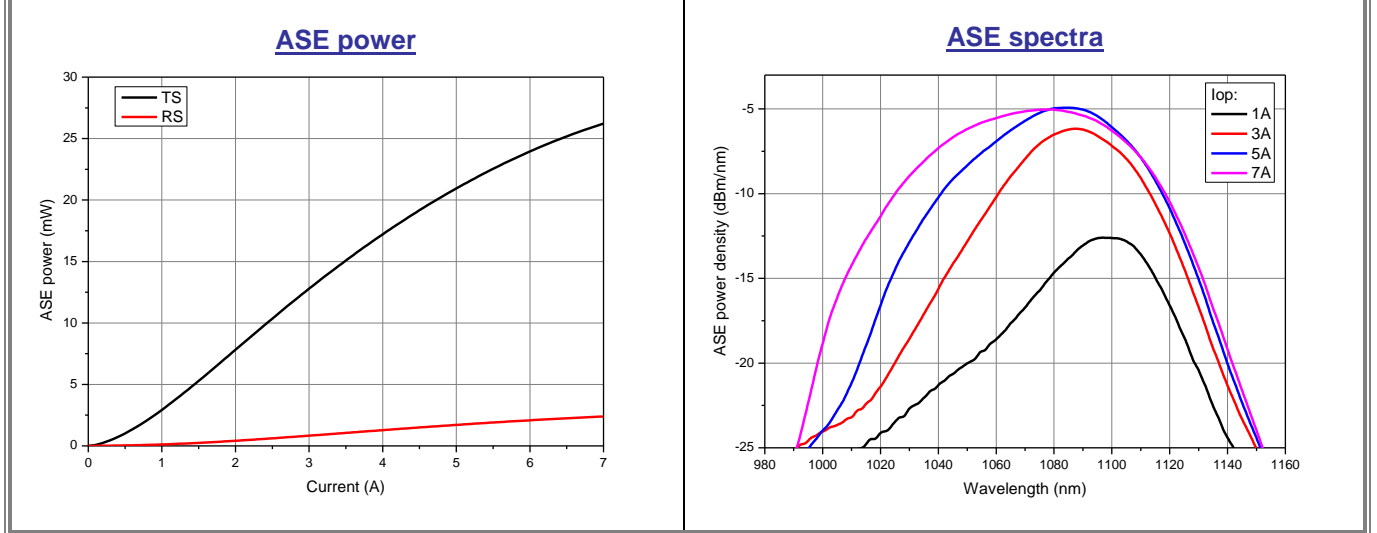

ABSOLUTE MAXIMUM RATINGS

Parameters	Min	Max	Unit
Diode reverse voltage		1	V
Forward current		8	A
Storage temperature (in original hermetically sealed package)	5	50	°C
Heatsink operating temperature	10	40	°C

CHIP VISUAL ACCEPTANCE CRITERIA

Top view: no indentations deeper 30um on cleaved edges, no scratches or indentations on mesa
 Front facet view: no particles or defects of coating in 10-um area around mesa

DIMENSIONS (subject to change)

(All sizes in mm)

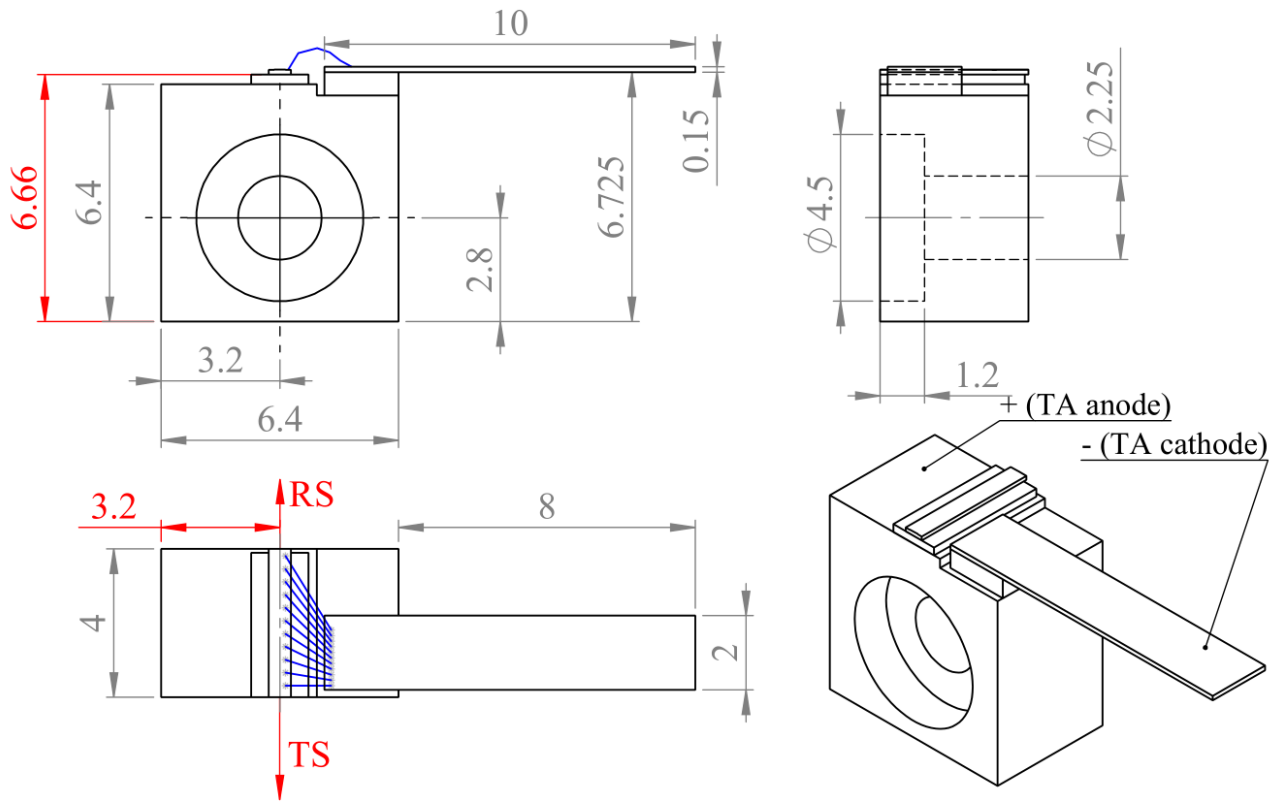

1. Tolerances ± 0.1 mm, unless specified otherwise;
2. Red colored dimensions referred to emitting point positions.

SAFETY AND OPERATING INSTRUCTIONS

The laser light emitted from this device is invisible and can be dangerous to the human eye. Avoid looking directly into the fiber output or into the collimated beam along its optical axis when the device is in operation. Proper laser safety eyewear must be worn during operation.

Absolute Maximum Ratings may be applied to the device for short period of time only. Exposure to maximum ratings for extended period of time or exposure above one or more max ratings may cause damage or affect the reliability of the device.

Operating the product outside of its maximum ratings may cause device failure or a safety hazard. Power supplies used with the device must be employed such that the maximum peak optical power cannot be exceeded. A proper heatsink for the device on thermal radiator is required, sufficient heat dissipation and thermal conductance to the heatsink must be ensured.

The device is an open-heatsink laser diode; it may be operated in cleanroom atmosphere or dust-protected housing only. Operating temperature and relative humidity must be controlled to avoid water condensation on the laser facets. Any contamination or contact of the laser facet must be avoided.

ESD PROTECTION – Electrostatic discharge is the primary cause of unexpected product failure. Take extreme precaution to prevent ESD. Use wrist straps, grounded work surfaces and rigorous antistatic techniques when handling the product.



NOTE: Innolume product specifications are subject to change without notice.